

'Good Husband Brand' Remote Lighting Lifter

National Patent Number:200520069085.5 200520075680.X 200520075677.8 200520075679.7

International Patent Number: PCT/CN2006/000409

Product Standard: Q/QABC002-2009

Instruction for Installation and Operation (Jan. 2013)

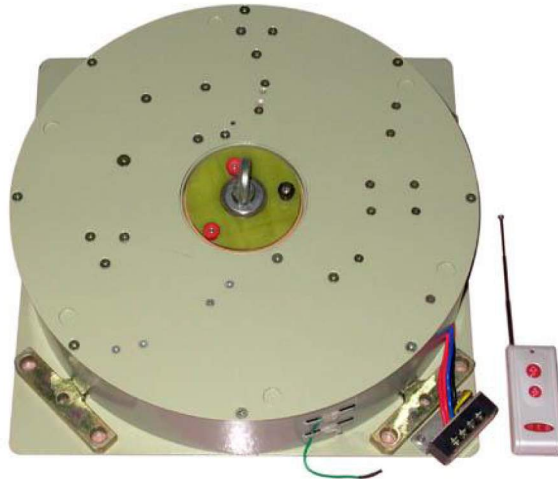

Lucktone Tech



Good Husband Brand

DDJ Series

100kg 5m

Model:**‘Good Husband Brand’****Contents**

○Brief Introduction of Product -----	02
○Points to Attention -----	05
○Specification and Technique Parameter -----	07
○Basic Components -----	09
○Optional Accessories -----	10
○Instruction for Installation -----	11
○Instruction for Operation -----	22

DDJ-50**DDJ-100****DDJ-150****DDJ-250**

Dear Sir / Madam:

Thank you for selecting Good Husband Lighting Lifter. We will provide you a modern, comfort and safety environment. Hope to receive your valuable opinion for our product and services.

△ To ensure safe operation, please read the manual carefully before using the lifter. Please keep the instruction manual properly for further reference.

△ Please entrust a professional technician to install the products to ensure safety.

▲ **Remote Lighting Lifter is a general lighting equipment which is not allow to use at the inflammable environment.**

Note: Please be tolerant that we will reserve the rights to make changes without notice.

Remote lighting lifter is a general illumination equipment which is easy to install, safety and convenient when in use and etc. Besides that, it is also allowing you easy to clean and maintain the lamps which were hanging at the higher place. It can be recognized as a modern decoration design and practical equipment which is worth to popularize.

The lifter is composed of Mechanism Driving Parts and Electronic Control Circuits [ECC]. The electronic control circuit contains a remote-control unit. The manual function of the wireless remote control is ascend & descend, stop/pause. However, the auto function of the wireless remote control is able to stop when the lifter is in the lower limit position & upper limit position or when the lifter is carrying weight over maximal loading capacity or weightless. The lifter has mechanical safe mechanisms to secure the chandelier when not in operation or during power failure and can be programmed to automatically stop at the optimum lowered position.

You no need to destroy your beautiful decoration or modify any original circuit even though you would like to install the lifter against the lamp that has been installed on the ceiling.

▲ Remote Lighting Lifter is general lighting equipment which is not allowed to use at the inflammable environment.

CAUTION OF INSTALLATION

1. Please refer to the diagrams first so as to avoid the damage occurred by improper installation and connection.
2. When you complete the installation of the lifter, the lifter must have more than 5kg weight on the steel wire rope on the installation or the lifter will not operate.
3. When the lifter is in use, people should keep the distance of at least 2 meters to stand or pass underneath a load to avoid the accident occurred.
4. The lifter is not allowed to operate when over carrying capacity.
5. The lifter should be tested before use.
6. The ways of inspection are as follows:
 - a) To check whether the connection between lifter and the expansion bolt of the ceiling is fixed well, and whether the ceiling is with its strong carrying capacity.
 - b) To check whether the power connection is accord with the requirement and earth wire is reliable.
 - c) Press 'DOWN' button on the remote control to descend the steel cable first (for around 60 seconds), then press any key to stop. After that, press 'UP' to raise the steel cable. Please refer to the page15, article 4.0 of the installation instruction for other inspection.

CAUTION OF OPERATION



Warning

1. The lifter only can be operated when it is carrying heavy.
2. Don't clean the steel wire rope with water or corrosive cleaner or the steel wire rope can be damaged.
3. Examine the steel wire rope regularly while in the process of cleaning lamps for any rusty, corrosive or damaged.
4. Please apply a coat of anti-rust grease on the steel wire rope after cleaning the lamps.
5. Please entrust a professional technician for its maintenance.

Specification

Model	Rated Load(kg)	Overall Size (L x W x H) (mm)	NW (kg)	Standard Lifting Height (m)	Lengthened Lifting Height (Max.)(m)
DDJ-50	50	330 x 330 x 60	8	4	10
DDJ-100	100	330 x 330 x 60	8	5	9
		350 x 350 x 80	15		18
DDJ-150	150	350 x 350 x 80	14	6	11
		450 x 450 x 110	25		20
DDJ-250	250	450 x 450 x 110	25	6	12

Note: Except DDJ250, the cable wire for every model can be extended specially based on its standard type.

Technique Parameter

No	Item	Model and Technique Parameter			
		DDJ 50	DDJ 100	DDJ 150	DDJ 250
1	Max. Loading Capacity (kg)	57.5	115	173	288
2	Lengthened Lifting Height (m)	4 ~ 10	5 ~ 18	6 ~ 20	6 ~ 12
3	Average Lifting Speed (m/min)	1.3	1.3	1.3	1.4
4	Power Consumption of Lifter (W)	120	200	213	430
5	Rated Current (A)	0.62	0.73	1.1	2.2
6	Rated Voltage (V)	220	220	220	220
7	Illumination Power Consumption (kw)	4	4	6	6
8	Illumination Rated Current (A)	18	18	36	36
9	Power Supply (ascend)	AC/220V	AC/220V	AC/220V	AC/220V
10	Power Supply (descend)	AC/220V	AC/160V	AC/160V	AC/160V
11	Dimension (mm)	330x330x60	330x330x60	350x350x80	450x450x110
12	Net Weight (kg)	8	8	14	25

Basic Components

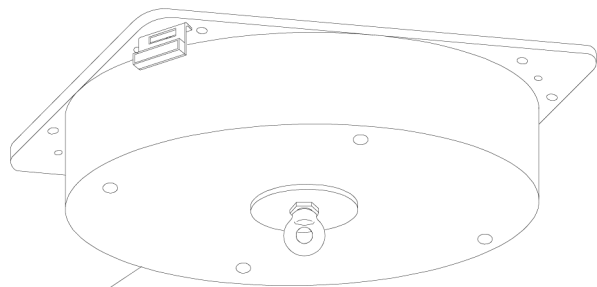

Lighting Lifter

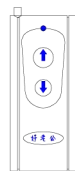

Remote Controller

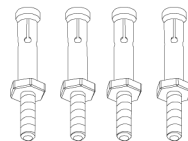

Expansion Bolt



Connection Cable for the Lamp

Diagram for Basic Components

Optional Accessories

Diagram for Optional Accessories

Note: The optional accessories should be conformed to the specifications of connection structure of ceiling lamp.

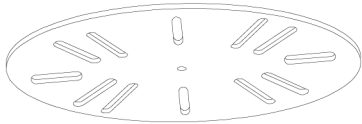

Connection Faceplate for the Lamp



Connection Part(s) for the Lamp

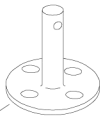

Connector

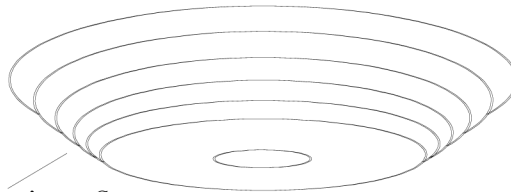

Decoration Cover

Instruction for Installation

Diagrams for Installation

I. How to connect the upper part of remote lighting lifter (Choose one)

1. The lifter can be installed directly on the ceiling concrete slabs with 4 expansion bolts. This is suitable for lifter rated load below 150kg.(Diagram 1)

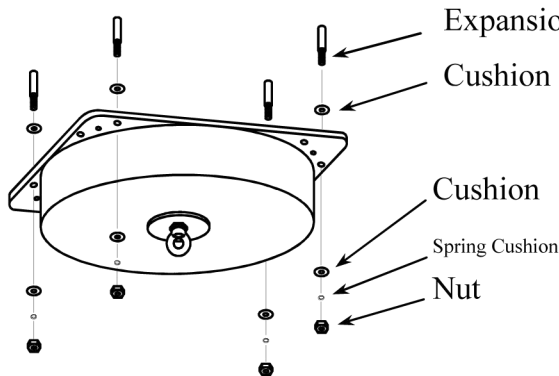

(Diagram 1)

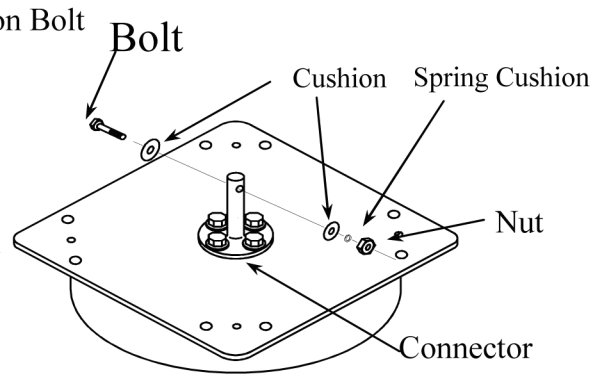

(Diagram 2)

Instruction for Installation

2. There is a fixed connector at the center of the upper square cover board with a column drilled an across hole on the out cylinder. This connector may be connected with the ceiling beam easily. This is suitable for lifter rated load below 150kg. (Diagram 2)
3. There are four corners at the upper cover board of the lifter which is assembling 4 full threaded screws. The space between lifter and ceiling is adjustable according to the sunshade height. This is suitable for lifter rated load below 250kg. (Diagram 3)

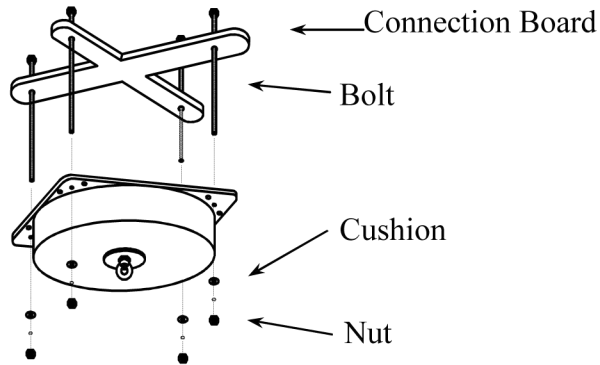

(Diagram 3)

II . How to connect the lower part of remote lighting lifter

1. The lamp should be linked with the ring (universal) at the center of the lower part of the lifter.(Diagram4)
2. The center place of the lower part of the lifter is equipped with a bar (optional part). There are 2 screws and nuts on the bar, which are for center distance adjustment. This connection method is suitable for the lamp with the weight of less than 50kg. (Diagram 5)

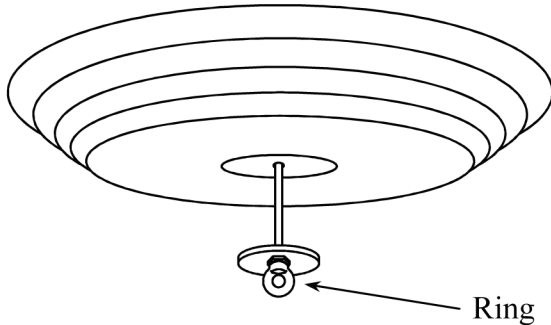

(Diagram 4)

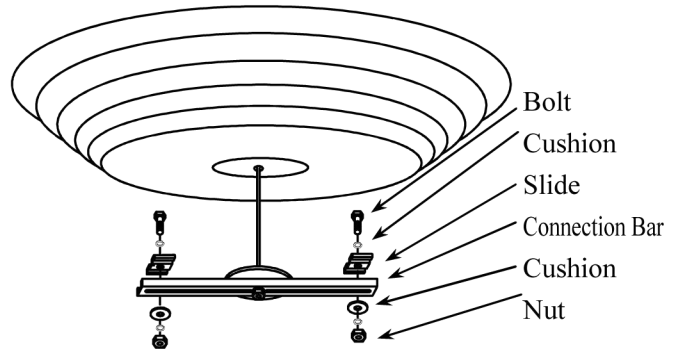

(Diagram 5)

Instruction for Installation

3. There is a faceplate (optional part) at the lower part of the lifter which provides multi-holes for the bolt connection. This is suitable for the bigger ceiling mounted. This connection method is suitable for the lamp with the weight of less than 100kg. The attachment is optional accessories. (Diagram 6)

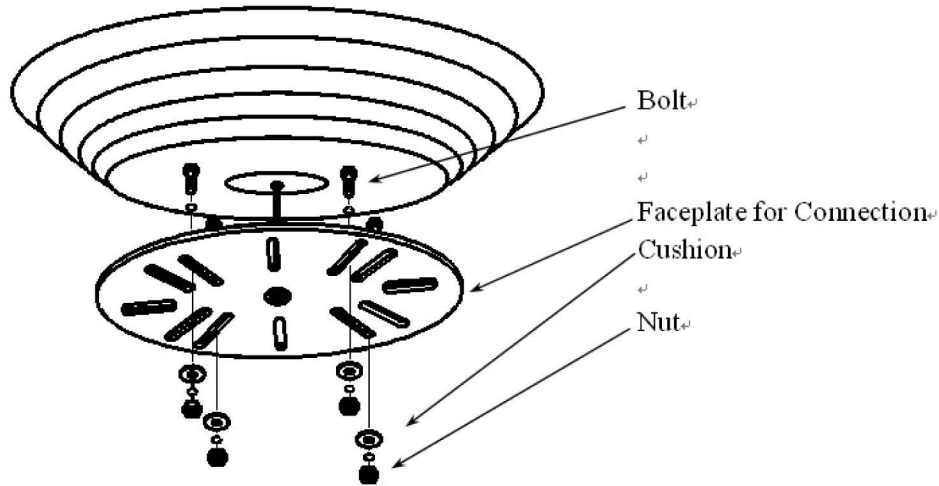

(Diagram 6)

4. Assembling Way for Bolt of Hanging Ring

Warning!

Before the lifter lower down the lower electric conductor, be sure not to assemble or disassemble the hanging ring unless the steel cable wire is extended 20cm at least from the lifter's body. When you assemble or disassemble the hand ring, please make sure the steel cable wire is not to be rotated. This is to ensure the steel cable not to be damaged by improper operation.

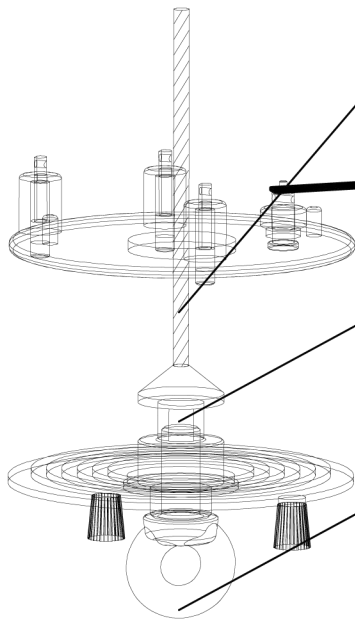

Safety Security

The position showing here is the most easy damaged section for the steel cable wire.

1. Please use a tool to fix this part so as to prevent it from being rotated.

2. Tighten the hanging ring bolt first, then tighten its nut.

III . The requirements and caution of the connection of upper part of the lifter

1.0 Tightened with expansion bolt(s). Please refer to Diagram 1.

1.1 All drilled holes should be handled strictly according to the technique requirements on the {Drilled Hole Specification for Concrete Slab---Table I}. The spare holes are located on the square board of the lifter for special condition use if there is reinforced when you are drilling the holes.

Drilled Hole Specification for Concrete Slab-----Table I

Model	Specification of Expansion Bolt (mm)	Diameter of Drilled Hole and Distance of Hole (mm)	Depth of Drilled Hole (mm)	Quantity of Bolts
DDJ50	M6 X 60	φ8 x 344 x 344	Min. 50	4
DDJ100	M6 X 60	φ8 x 344 x 344	Min. 50	4
DDJ150	M10 X 100	φ10 x 382 x 382	Min. 80	4
DDJ250	M10 X 100	φ10 x 484 x 484	Min. 80	4

1.2 Tighten the nuts firmly to ensure the force balance of each bolt. Please refer to {Nut Tightening Force Moment---Table II}.

Nut Tightening Force Moment ---- Table II

Hexagon Head Set Nut (Screw) M5	3.24N/m	Note: The performance level of the nut \geq Grade 5; The performance level of the screw \geq Grade 6.8. Galvanized surface; The surface should not be coated with grease before tightening and the tightening force moment should not be lower than the reference data on this table.
Hexagon Head Set Nut (Screw) M6	5.5N/m	
Hexagon Head Set Nut (Screw) M8	15.5N/m	
Hexagon Head Set Nut (Screw) M10	26.4N/m	

2.0 Roof beam installation (refer to diagram 2)

2.1 There is a connector in the middle of the lifter, which is for steel pipe connection. The wall thickness of steel pipe should be more than 3mm. The across hole on the steel tube is drilled based on the bolt diameter.

2.2 The connection of steel pipe and steel beam should be completed by qualified technicians to ensure the connection is reliable.

3.0 Connection with 4 long screws (refer to diagram 3)

3.1 Make a square board according to the technique requirement of the attached diagram. The connection of the square board and steel beam should be completed by qualified technicians to ensure the connection is reliable.

- 3.2 The lengths of the screws are subject to the size of decoration spaces. Assemble with 4 long screws to adjust the upper cover board of the lifter in proper level position, then, tighten the nuts. Please refer to diagram 3.
- 4.0 Connection reliability test must be applied when completing the upper part installation of the lifter. The test weight should be 1.5times of the rated load. Lift up the heavy with the acceptable weight first when testing. (The lifter will not operate when it is overweight) Please press the key when there is a height of 20mm away from the ground. Then, add another half as much as the weight and hang it for 5 minutes. The upper part of the lifter is qualified if it is hung well. You have to recheck the installation process if it is not hung well when testing until it is qualified.

▲Important Warning: The operators have to wear the safety helmet during operation. When the lifter is in use, people should keep the distance of at least 2 meters to stand or pass underneath a load. You have to use the steel tube which the length is 2m to carry the heavy by 2 persons when you would like the lifter become heavier. This is to prevent from dropping off due to the unqualified concrete slab strength.

▲Importance: The lifter must have more than 5kg weight on the steel wire rope on the installation before start, only then, it may descend. When the lifter is fully earthed, you have to pay attention to the steel wire rope after releasing the ring to avoid people is hurt. You have to stretch the steel wire rope first before you carry on the connection testing.

IV. The requirements and caution for the connection of the lower part of the lifter and the lamp

- 1 . The attached U-shape ring may be connected firmly to the lamp by the installer. Please refer to diagram 4. The specifications for the bolts must be accord with the following:

M10 bolt is used for the lamp with the weight of less than 150kg. M12 bolt is used for the lamp with the weight of less than 150-250kg. The bolts have to accord with the criterion of Hexagon Head Set Nut (Screw) with Grade C GB/T5780-1986.
- 2 . Place the attached bar into the center screw position for the lower part of lifter by the installer, then, tighten the bolts and nuts. Move the nut which is slide on the bar to the proper bolt hole of the lamp. Tighten the screw according to the requirements of Nut Tightening Force Moment-Table II. Please refer to diagram 5.
- 3 . Assemble the attached faceplate into the center hole position for the lower part of lifter by the installer, then, tighten the bolts and nuts. Make sure the bolt holes and faceplate slots are properly in place. Tighten the nuts according to the requirements of Nut Tightening Force Moment-Table II. Please refer to diagram 6.
- 4 . The decoration cover should be installed after the upper part of the lifter is complete and qualified (before the lower part of the lifter is installed) .

V. The connection of power supply and caution

1. Connect the live, neutral and earth wire of the input, supply to the corresponding points with the voltage of Ac220V. Please refer to the diagram 7.
2. You have to connect the power supply and lower conductor of the lifter according to wiring diagram 8. Please connect the live wire into L1 if the power of the lamp is lower. There are a lot of live wires when the power of the lamp is higher. Please divide the wires into two groups and connect them into L1 and L2 separately.

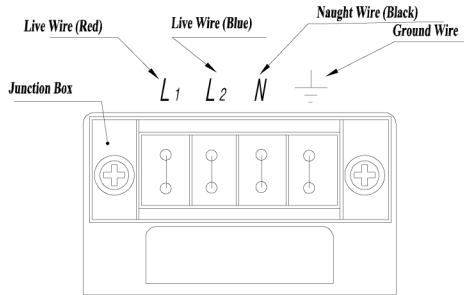

Wiring Diagram for Power Supply Input
(Diagram 7)

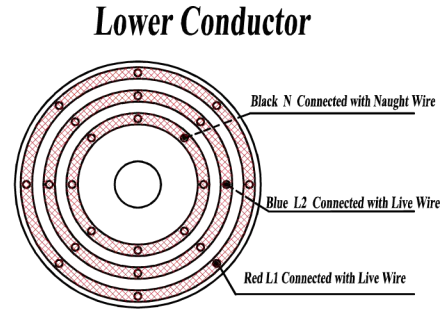

Wiring Diagram for Power Supply Output
(Diagram 8)

3. Please make sure the exposed wires which are corresponding to the terminal are properly in place while you connect the wires so as to prevent them from contacting the metal conductor surrounding and power leakage.
4. The stamped screws should be tightened and rechecked one by one to ensure the connection is fixed well when in the process of connection.



Warning

Attention to Maintenance between Lifter and Lamp

1. After the lamp drop and lifter stop later, the lifter still contains electric, please turn off the switch which control this lamp, only then, you may carry on in the maintenance work.
2. There are not allow having the wet water, greasy dirt, coherences metal and so on appear at the electric conduction contact face while in maintenance.
3. You should keep the tension with 5kg of the steel wire rope while in maintenance. When the steel wire rope descend too long, it will twist or loop itself and be able to affect of using the steel wire rope.

Instruction for Operation

Operation Instruction of Remote Controller

UP Key

Press UP for one second when the lifter is in the state of stop. The lifter begins going up.

Press any key for one second when the lifter is going up. The lifter stops operating

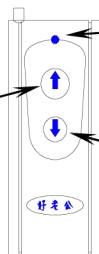

Indicator

DOWN Key

Press DOWN for one second when the lifter is in the state of stop. The lifter begins going down.

Press any key for one second when the lifter is going down. The lifter stops operating.

Remote Controller

Points to Attention

- Pull out the antenna when the remote controller is in use.
- Point the remote controller to the lifter when it is in use.
- The effective distance of remote control is 25m.
- Not allow liquid enter into the remote controller. To avoid direct sunlight.
- Don't throw the remote controller.



Battery Change of Remote Controller

- If the indicator becomes dim or is off when the power on, change a new battery.
- If the remote controller is ineffective or is not sensitive, please change the battery.
- The battery size is 9V.

1. Operation Instruction of Remote Controller

- The lifter only can be operated up and down in 3 minutes when you power on the lifter. That is said the hand remote only be effective in 3 minutes after you power on the lifter. If you have powered on the lifter exceeding 3 minutes, and you want to operate the lifter, please re-power on the lifter will be ok.

- **“UP”**: Press ‘UP’ button on the remote control to raise the steel wire rope. The operation is ineffective if you press any key to stop within 2 seconds. At this time, the lifter will not operate.

Test for the upper limit position: The switch of the upper limit position will switch off and the lifter will stop automatically when the steel wire rope going up until the upper limit position. At this time, the operation is ineffective if you press ‘UP’ button again.

- **“DOWN”**: Press ‘DOWN’ button on the remote control to descend the steel wire rope. Press any key to stop it. If the steel wire rope going down to the lower limit position which you setting before and stop automatically. At this moment, the operation is ineffective if you press ‘DOWN’ button again.

2. Memory function setup for lower limit position of remote control (Instruction 2)

Setup the lower limit position of remote control: Press ‘DOWN’ button on the remote control to descend the steel wire rope for around 5 seconds when you turn on the lifter. When the steel wire rope goes down to the required height, please keep press ‘DOWN’ button until the lifter stop automatically. After that, please use another hand to press ‘UP’ button on the remote control when the steel wire rope goes up a little bit again. Please release the two buttons when the steel wire rope goes down again. At this moment, the memory lower limit position of control unit has been set up successfully. If there is other

operation applied suddenly during the steel wire rope going down, the lower limit position of the wire rope will not be controlled by the main unit memory. At this time, the lower limit position should be controlled by people. However, the memory lower limit position of control unit will remain same and auto stop function is still effective when the lifter goes down next time.

3. Reset memory function for lower limit position of remote control

- **Cancel the setup:** Please keep press 'DOWN' button for around 8-10 seconds and release it when the lifter has reached its lower limit position. After that, press 'UP' button on the remote control, the lifter will reached its upper limit position and stop automatically. At this time, the memory setup has been cancelled.
- **Renew the setup:** The memory datum of the lifter will be renew if you reset it according to the instruction 2.

4. Function for reset signal code:

Keep press up and down buttons for around 8-10 seconds and release it after the lifter is electrified within 5 seconds. The lifter will go down if you press 'DOWN' button on the remote controller. At this time, the instruction for signal code has been reset successfully. You have to reset the memory function for remote control lower limit position otherwise it is ineffective.

Warnings!

- After the lifter set up the height of lower limit position, the lower limit position of the lifter will not be controlled by the main unit memory if the artificial operation halts the lifter suddenly while it is going down. At this time, the lifter should be controlled by people and you have to pay attention to the safety.
- People cut off the electricity suddenly while the lifter is operating and it will cause the signal code lost and malfunction.
- People cut down the heavy until the machine stop suddenly while the lifter is operating and it will cause the lifter malfunction.
- **When the lifter is operating, the lighting fixture rotates slightly. Please not to hold the lighting fixture and not to prevent it from rotating, otherwise, the steel cable wire will be broken or become loose and cause any accident.**

The installers MUST read the instruction manual carefully before install the remote lighting lifter.

‘Good Husband’ Lighting Lifter

Makes Cleaning Simple and Convenient
