

**ZLW-280L**

**ZLW-281R**

**ZLW-280L and ZLW-281R**...Rarest of the rare--reproduction. In 1858, *Russell & Irwin* created a marvelous series of surface locks in cast iron w/-brass bolts & cam pieces. This set, called the "Pioneer Lock" was patented Aug 20 1858. Originals are selling from \$600up even w/-broken & missing pieces. Our's are complete with self colored iron case and brass working parts. Case meas: 4 1/2" tall x 3 9/16" deep. Catch: 4 1/2" x 1". Made by Lost Wax casting..just like jewelry. The scene is a hunter, walking in a forrest, w/his knapsack, gun & dog

**Supplement #4-1a**

**ZLW-252 and ZLW-291**  
Use the same latch with slight modifications. Latch size: 2 7/16" wide by 2 5/16" tall. Catch: 9/16" wide & 2 5/16" tall. Bolt shoots: 7/16"  
Dial of ZLW-291 dia is 2 1/4"  
(screw flags make the height 3 1/4")  
Note emergency open from outside. Fits a dime-coin  
Steel shaft supplied.

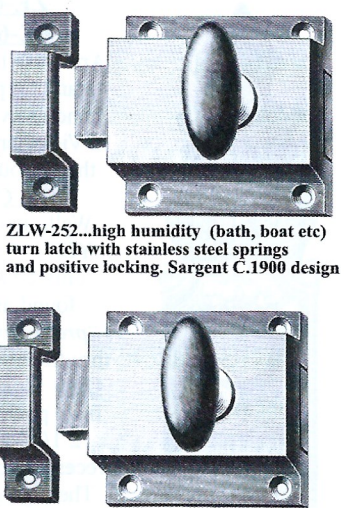

**ZLW-252**...high humidity (bath, boat etc) turn latch with stainless steel springs and positive locking. Sargent C.1900 design

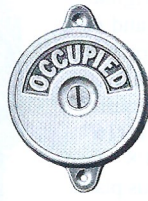

**ZLW-291**...High humidity (bath or boats) turn locking latch with outside indicator dial. Has stainless steel springs and positive latch points. Solid Brass here now. (Nickel plated version due Jan 04) Sargent C. 1900 w/ design improvements which are "design and function" copyright reserved. Comes complete with steel connecting shaft with most desirable *cut point* marks.

**L-299PL (plain design) and ZB-299WN (windsor pattern) and ZLW-299RC (victorian design) & ZC-299AC (not illus. Arts & Crafts hammered copper face) Locks**....Look at L-299PL for the set-backs. Lock body: 3 3/4" tall, 3 3/16" deep and 5/8" thick. Face Plate: 1" wide by 6" tall & 3/16" thick.

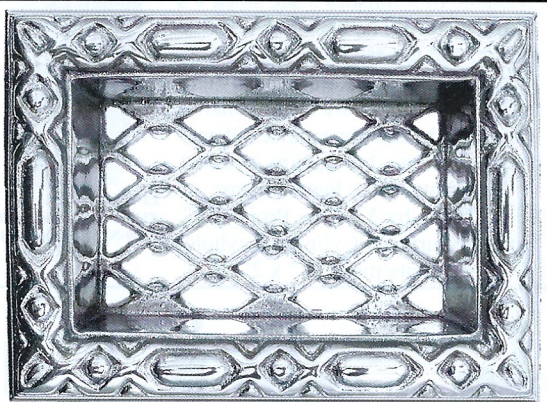

**ZM-MS1 (iron) Foundation Grates ZM-MS3B (brass)**

**ZM-MS1 and ZM-MS3B**...Brick foundation grate. Could be used else-wise...but boot is 4 5/8" x 7 1/2" to fit in a brick course, depth 2 1/2", 7" x 9 3/4" OA.



**W-4 series**

**W-4 Gallery Rail series**  
Long-lost Stage Sideboard Gallery Rail Posts for 1/2" rail. W-4 post is cleverly designed so a disk mounts on the sideboard w/-wood screws and then the post mounts to the disk with a 1/4" machine thread. All tightened by the top finial.  
**W-4A** Thru drilled top  
**W-4B** Stop post-1/2 drilled

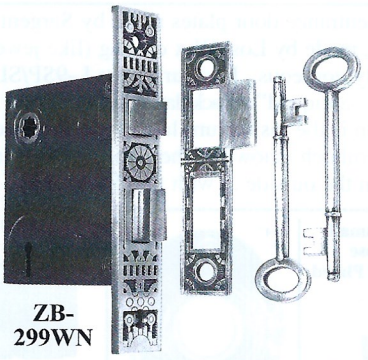
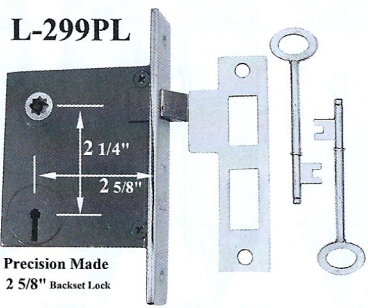

**W-4C** Corner post 90° holes  
**W-4T18** 1/2" tube 18" long  
**W-4T30** 1/2" tube 30" long



**A-118**...Small STEEL (not zinc) antiqued bin pull. Lovely size with roughened and aged finish that looks old. 3 1/4" x 1 1/4". Screws: 2 3/4"cc

**A-22**...Arts & Crafts IRON hook. Sand cast, painted black; & w/-clean design 5 1/2" tall; Projects: 3 5/8" Backplate: 2 1/2" x 9/16"; Screws at 2 1/8"cc



**A-22 Arts & Crafts Iron Hook**

**B-52SL & B-N52SL**  
Small sunken pull, or lift, or closer.  
OA: 3 3/16" x 1 3/4". Screws fasten inside recess at 2 7/16"cc  
Recess: 2 3/8" by 15/16" & 1/2" deep

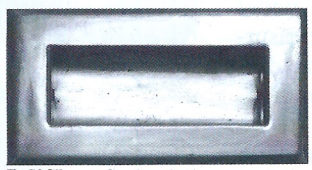

**B-52SL (Brass) Sunken Lifts B-N52SL (nickel plated)**

**L-250 & L-N250**  
Probably the finest latches, of this type, on the market today. Absolutely great quality of knob and action compared to others that simply, fall apart. Ours works as smooth as silk. Latch: 2 1/8" tall by 1 1/2" wide. 1 5/8" knob height. Catch is also 2 1/8" tall by 3/4" wide. Tongue protrudes: 3/8" Available is polished solid brass & Nickel plated solid brass.

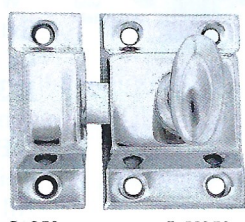

**L-250 (brass) L-N250 (nickel plated)**

**L-148**...Small sliding door hidden pull. The face is 3 3/8" x 5/8" while the fully mortised pocket, required to install this unit, is 2 1/4" by 9/16" and 7/8" deep.



**Sliding door Hidden Pull**

**L-148**